



**Pro Series Digital
SLR Auto-Focus
TTL Flash w/LCD Display**
wide angle bounce diffuser & adapter

**Item # XTSB1010
INSTRUCTION MANUAL**

designed for

Nikon

X Features

- ✓ High GN: 68
- ✓ Wireless trigger sensor
- ✓ Recycle time 4 seconds (with 4 pcs AA alkaline cell)
- ✓ Compatible with E-TTL flash automatically
- ✓ Support Multi-flash lighting Application (s1/s2 mode)
- ✓ Power saving mode
- ✓ Accurate brightness control
- ✓ LCD display
- ✓ Metal hot shoe
- ✓ Support front curtain synchronous
- ✓ Support rear-curtain synchronous
- ✓ Temperature detection Automatically (overheating protection)
- ✓ Memory function

X Components

1. Reflector panel
2. Wide-angle diffuser
3. Flash head
4. Wireless trigger sensor
5. Battery cover
6. Hot Shoe
7. Locking ring
8. Hot shoe pin
9. Locking pin

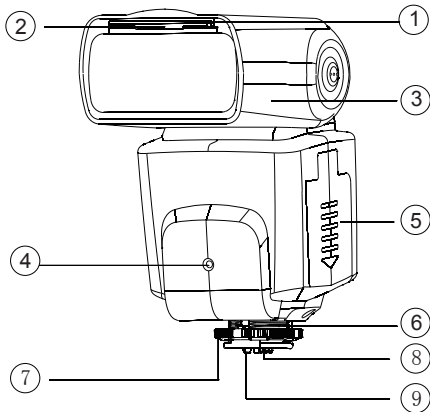

X Components

- 10. LCD display
- 11. Mode switch button
- 12. Charging indicator
- 13. Test button
- 14. Zoom button
- 15. Power ON/OFF
- 16. Adjustment button
<left right button>
- 17. SET button

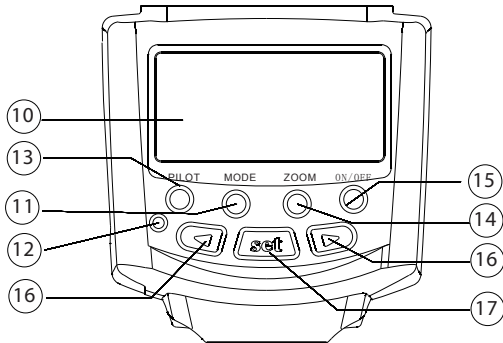

X Installation

1. Insert batteries

- Slide the battery compartment cover in the direction of the arrow to open it.
- Insert the batteries follow the direction inside the battery compartment cover, Make sure to place the positive and negative of the batteries correctly.
- Slide the battery compartment cover in the direction of the arrow to close it.

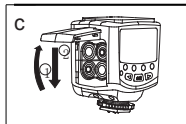
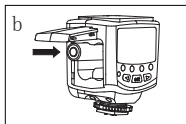
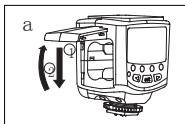

Note: Please use 4 pcs standard AA batteries. *Please don't use damage batteries, so as to avoid short circuit.*

2. Install the speedlite on the camera.

- a. Rotate the locking ring in the direction of the arrow to the highest point.
- b. Mount the speedlight into the camera's hot shoe completely.
- c. Turn the locking ring in the direction of the arrow tighten, if you detach the speedlight, loosen the locking ring to the top, then remove the flashlight from camera's hot shoe.

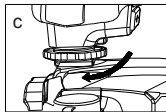
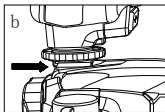

X Status of charging indicator

Test status of charging indicator after turn on the speedlite.

Status of charging indicator	Meaning	Operation
The red light is lit	Charging	Normal
The green light is lit	The batteries are full	Normal
Green blink	The speedlite is locked because of the frequent flash,overheating protection.	Stop about 2 minutes, waiting for flash cooling
Red blink	Low power or long time charged	Turn off to change battery or turn on again

X Basic functions

1. Basic Operations

Operation of the buttons:

Components	Operation
<Power Switch>	The power of flashlight can be opened or closed by holding this button for 2 seconds.
<Mode Switch Button>	Press once, the mode will change among the TTL/M/ M /S1/S2.
<LEFT>and <RIGHT> button	Press this button to adjust the output power of the speedlite.
<ZOOM> button	Press this button and the up and down keys to adjust the focal range of the speedlite. Press once, the focal range will be among 18/20/24/28/35/50/70/85/105/135/150/180MM
<Pilot> Button	Press this button to test the input brightness of the speedlite.

X Basic functions

2. Turn on/ off the speedlite

2.1 Turn on the speedlite

Pressing ON/OFF button 2 seconds, LCD screen can display. If the charging indicator is red, wait for it to turn green. then the speedlite can be used. the red light means the speedlite is charging, the green means the flash can be used.

- **2.2 Speedlite testing**

Press (PILOT), then the speedlite is flashing.

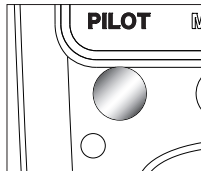
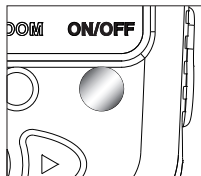

Turn on/ off the speedlite

2.3 Turn off the speedlite

The power of flashlight can be closed when pressing ON/OFF button 2 seconds.

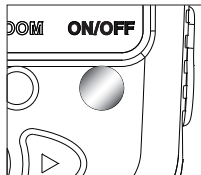

X Basic functions

3. Memory function

The speedlite will recover the last mode and setting when it's turned on again.

4: TTL mode

The speedlite will flash automatically via the lense of the camera.

- 1 The speedlite is showed as the picture when it is on.

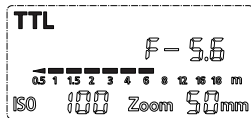

- 2 **Decrease the exposure index**

Press the “◀” button to decrease the exposure index, fine adjustment from 0, -1/3, -2/3, -1…… -3 nine grades

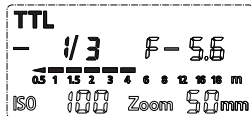

X Basic functions

TTL mode

3 Increase the exposure index

Press the “▶” button to decrease the exposure index, adjustment from 0, 1/3, 2/3, 1 …… 3 nine grades

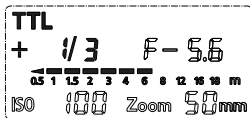

4 How to use TTL

- Half press the shutter button for focusing
- The speedlite connects the camera and show the index of the aperture of the camera and the focal length of the lens.
- Press the shutter to photo, the speedlite will flash (TTL) automatically.

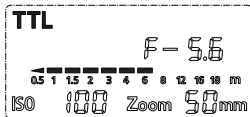

X Basic functions

5: M mode

Under the M(Manual setting) mode,you can set the flash index as you like.

- 1 Press <mode> button to change to M mode
The picture is the M mode interface of the speedlite.

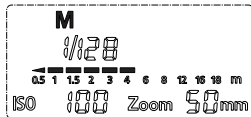

- 2 Increase the brightness of the speedlite.
Press the "▶" button to set the brightness of the speedlite. The maximum brightness value of the speedlite is 1/1 (There're 3 grades of power fine adjustment on every gear)

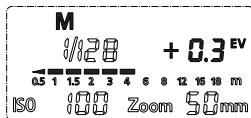

- 3 Decrease the brightness of the speedlite.
Press the "◀" button to set the brightness of the speedlite. The minimum brightness value of the speedlite is 1/128 (There're 3 grades of power fine adjustment on every gear)

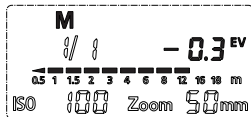

X Basic functions

6: Strobeflash(⚡) mode

Strobeflash is a kind of model that can analyse the motion of subject.

Under the strobeflash mode, the flash can photo a series of moving subjects for many photos. You can set the flash rate. (the flash times one second, use HZ to represent it), flash times and flash input.

- 1 Press <mode> to change to the strobeflash mode.
The picture is the interface of the strobeflash.

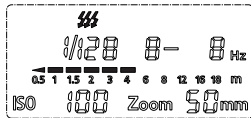

- 2 Increase the input brightness of the flash
Press the "▶" button to adjust the input brightness of the flash. The maximum brightest setting of the flash is 1/4
(There're 3 grades power fine adjustment of every gear)

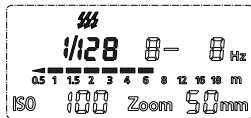

X Basic functions

Stroboflash(⚡) mode

- Decrease the input brightness of the flash
Press the "◀" button to adjust the input brightness of the flash. The minimum brightness setting of the flash is 1/128
- The strobe flash setting
Press <SET> button, the "8" is blink, then you can set the strobe flash time of speedlite. The times of the strobe flash is from 1 to 90 (more parameters setting see P44 form). When the number of the times is set, you can adjust flash frequency press <SET> button again.
- The setting of the stroboflash
Press the SET button, there's "8" blink. Then you can use "◀" "▶" button adjust the frequency from 1 to 100 (more parameters setting see P44 form).
 - The flash parameter will be saved and quit after press set button again.
 - The flash will be saved and quit if parameter was chosen blink in 10 seconds.

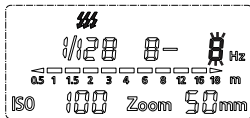
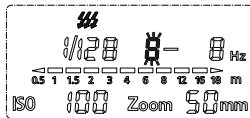
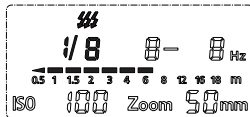

X Basic functions

4 Reference output frequency and times

Frequency div. times ind. out	1HZ	2HZ	3HZ	4HZ	5HZ	6HZ	7HZ	8HZ	9HZ	10HZ	20HZ	30HZ	40HZ	50HZ	60HZ	70HZ	80HZ	90HZ	100 HZ
M1/8	14	14	12	10	8	6	6	5	5	4	4	4	4	4	4	4	4	4	4
M1/16	30	30	30	20	20	20	20	10	10	8	8	8	8	8	8	8	8	8	8
M1/32	60	60	60	50	40	32	28	24	22	20	12	12	12	12	12	12	12	12	12
M1/64	90	90	90	80	70	56	44	36	32	28	24	24	24	24	24	24	24	24	24
M1/128	90	90	90	80	70	56	44	36	32	28	24	24	24	24	24	24	24	24	24

X Basic functions

7:S1/S2 mode

S1/S2 mode is used as off-camera auxiliary to create various lighting effects. The S1 mode is suitable for manual flash environment, the S2 mode is suitable for TTL flash environment . Under these two modes, the adjustment of the output brightness of the speedlite is as the M mode.

S1 When the flash is in S1 mode, it will flash with the first work of the master flash sync, the same effect as the use of radio slave. To use this mode correctly, the master flash should be set as manual flash. And the TTL flash system with preflight function and the red-reduction function with multiple flashes should not be used. S1 flash once can press “◀” “▶” to adjust the brightness of the flash.

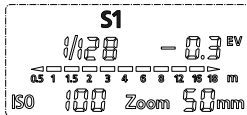

X Basic functions

S1/S2 mode

S2 S2 mode is namely "pre-flash cancel mode". It is similar to S1 mode, But it can ignore the pre-flash given by TTL flash. Therefore, it can support the main flash working in TTL mode. In particular, if S1 mode can not flash correctly and synchronically with your internal flash, you can try the S2 mode. (The function is suitable for the cameras of CANON and NIKON)
S2 preflash can through the "◀" "▶" to adjust exposure brightness

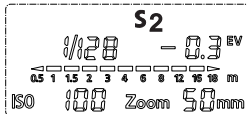

1. Whatever mode your flash, press the "◀" "▶" button for more than 1 second, then you can reset the parameters of the flash by fast-forward or fast-backward.
2. All parameters can be seted recycling, except for manual set the zoom function.

X Basic functions

8. Sleep mode

The flash will entry sleep mode if have any operation in 30 seconds. it can be wake up through any button.

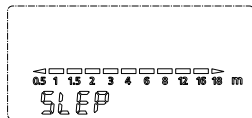

9. ISO Display

Camera ISO synchro to flash when shutter release half-press, flash screen will hint "ISO-A" when camera set "auto ISO sensitivity control" on.

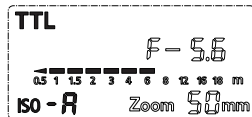

10. High speed sync

The flash LCD will hint "H" word when set camera to "auto FP" on (Pay attention: software support shutter release 1/320 sync).

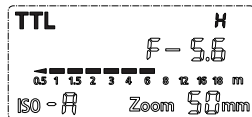

X Basic functions

11. Rear-curtain synchronous display
Flash LCD will hint “▶▶” when camera set to rear-curtain synchronous.

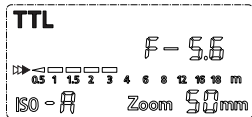

12. Aperture set
Press set button entry operture mode, you can use “◀” “▶” button adjust aperture from F-1.0 to F-64.
13. Manul setting the flash head zoom position
You can adjust the zoom position of the flash head whenever which mode the speedlite is. The default focal length of the speedlite is 50MM. Press the ZOOM button, the “50” is twinkle, then you can adjust when press the “◀” “▶” button, It will be saved when you press zoom button again.
14. Test Flash
In any mode, you can press PILOT button to test if the flash lighth flashed normally.

15. Recover factory settings data

At first continue to press <SET> button, then put batteries into speedlite, you can see manufacture data.

16. Overheating protection

If the flash light is used too frequently, its overheating protection function will be triggered, the red and green lights of the charging indicator will blink alternatively, and the flash light will be locked. In such case, wait indicator to be green then cancel the protection before continuing the use.

* Please try to use the 1/4 output or lower when rapid shooting is needed to prevent the effect on the shooting.

X The Advanced Application

1. Multi-flash Lighting Application

Use inbuilt flash or top-mounted flash as master flash, Place speedlite in different directions.

*In indoor application, radio signals can be reflected by walls; therefore, the placement of the slave flash should have more space. Wireless triggering distance is up to 20-30M.

*which can be available in outdoor state. The Wireless triggering distance is as long as 10-15M, Please keep in mind the following tips; the wireless triggering window needs to face the master flash and the direct sunlight shall be avoided. If these demands conflict with your hoped direct ion of light irradiation, please try to rotate the flash head in each iirection in order to meet the shooting demands.

*Before placing of the slave flash, test whether S1/S2 can be synchronous normally, Do not place any obstacles between the host flash and the slave flash, because they may block the transmission of radio signals.

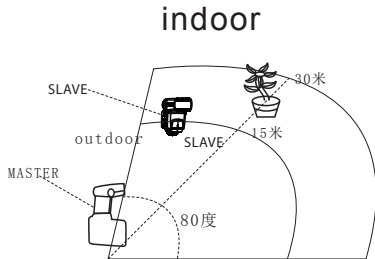

X The Advanced Application

c. Multi-flash, wireless trigger
one master, two slave

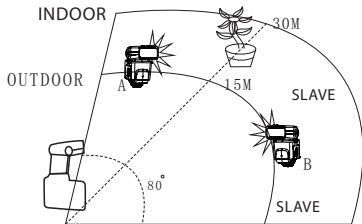

One master, three or more slave

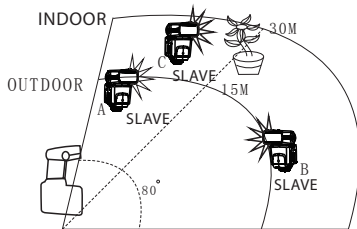

2. Reflection Flash

Bounce flash means to take photos by making flash light head aimed at wall or ceiling and using the light reflected back from the ceiling or wall to light the desired object, so that the shade behind the object can be decreased to get more natural shooting effect. If the wall or ceiling is too far, the bounce flash may be too weak to get enough exposure. The wall or ceiling should be even and white in order to get efficient reflection; if the reflection surface is not white, color cast may appear in photo.

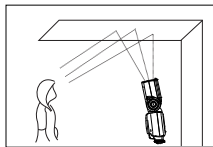

3. Use Reflection Board to Take Photos

With the reflection board flash, draw the reflection board and the wide-angle diffusion board out from the light head at the same time and then push the wide-angle diffusion board back. In such case, if this product is being used to take photos, it will produce a high lighted point on the eyes of the subject and

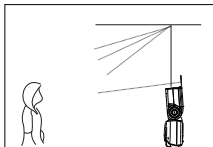

X The Advanced Application

thus make the eyes charming(catch light), this function can reach optimal effect when the flash head is up 90 degree.

4. Use Wide-angle Diffuser

Pull out the wide-angle diffusion board, push back the reflection board and arrange them as per the figure; in such case, the flash scopes will extent to 18 mm and the flash effect will be softer and more natural.

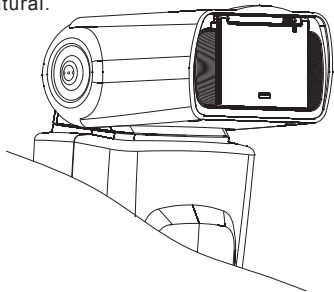

X Specifications

Circuit design	Insulated Gate Bipolar Transistor(IGBT)
Guide Number	68 meters (ISO 100,105mm)
Flash mode	TTL,M,MULTI,S1,S2
Vertical rotation angle	0-90 degrees
Horizontal rotation angle	0-270 degrees
Power supply	4XAA size batteries(Alkaline or Ni-MH are usable)
Lighting times	100-1500 times(AA alkaline cell used)
Recycle time	approx. 4s
Color temperature	5600k
Flash time	1/200s--1/20000s
Flash control	8 levels of output control(1/128--1/1)
Wireless triggering distance	20--30m indoor,10--15m outdoor
Additional features	FEC,AEB,Manual zoom,Auto zoom
Dimensions	165*74.6*59.2mm
Net weight	275g
Accessories	Flash light(1),protecting bag(1),mini stand(1),manual(1) and warranty card(1)

X Guide number of different focal length range(at ISO 100, in meters / feet)

430 GN: 68 ISO 100 (meters / feet)

Flash output	Coverage(MM)						
	24	28	35	50	70	85	105
1/1	20/66	22/72.6	25/82	27/88.6	30/98.3	33/109.2	36/118.1
1/2	12.2/40.1	15.3/45.9	17.7/58.1	19.1/62.7	21.9/71.9	24/87.7	26.2/86
1/4	8.8/28.9	11/36.1	12.5/41	13.5/44.3	15.5/50.9	17/55.8	18.5/60.7
1/8	6.3/20.7	7.8/25.6	8.8/28.9	9.5/31.2	11/36.1	12/39.4	13.1/43
1/16	4.4/14.4	5.5/18	6.3/20.7	6.8/22.3	7.8/25.6	8.5/27.9	9.3/30.5
1/32	3.1/10.2	3.9/12.8	4.4/14.4	4.8/15.7	5.5/18	6/19.7	6.5/21.3
1/64	2.5/8.2	3.2/10.5	3.1/10.2	3.4/11.2	3.9/12.8	4.3/14.1	4.6/15.1
1/128	2.5/8.2	2.7/8.9	3.2/10.5	3.7/12.1	4.4/14.4	4.7/15.4	5.1/16.7

X Possible problems during use and solutions

1. Please note when use the flash outdoors:For outdoor application,please avoid direct sunlight to the wireless triggering sensor and ensure normal use of the flash.
2. Precaution for outdoor use of lambrancy umbrella; The lambrancy umbrella mounted on the flash light outdoors may be blown down easily ,and the hot shoe of the flash light may be broken.Please fix the mounting rack or avoid outdoor use.
3. Photos are under exposure or over exposure?Check if the set shutter,aperture and ISO are too near the flash limit or if some settings including exposure compensation in relation to flash are proper.
4. Vignetting appears in photos or only part of the subject is illuminated?Please check the current coverage of focal length and make sure if the lens focal length exceeds the coverage range of the flash.The products's zooming range is 18-180mm of the medium format system. you can try to pull out the wide -angle diffuser to expand the flash range.
5. The flash light is abnormal?
Switch off the power of flash light and camera,mount the flash light on the hot shoe of camera, and switch on the power of flash light and camera again, If the abnormality continues,replace the batteries.
6. In use process have function abnormal or part of the failure of function, can detach flash to installed the new battery then turn on again for recover normal use. For abnormal use may caused error state, under turning on status,replacement battery directly,the battery capacity lack, hot shoes too loose to happen badness contact, etc.

X Possible problems during use and solutions

7. Install batteries but can not turn on?

Check the battery pack, the electricity shortage, old and new batteries or different brand battery in practice. if have these situation pls as to the right way to install batteries.

*Caution: long time no use, please featch out batteries.

The functions of this manual are based on test conditions of our company. Further notice will not be given if the design and specifications change.

