



**Universal
High Power Auto-Focus
Digital SLR Flash**

wide angle diffuser & reflection board

**Item # XTDF260
INSTRUCTION MANUAL**

designed for

D-SLR

X Warning

1. To avoid fire or electrical shock, do not expose this product to rain or moisture.
2. Do not flash at high level output continuously for over 15 time.
3. To avoid short circuit, be sure the batteries contacts are securely packed and in accordance with local provision when handling the batteries.
4. Please place the batteries and the parts which can be swallowed mistakenly away from children. Contact a doctor immediately when it occurs.
5. To avoid possible injury to eyes, do not use the flash light on the people who need a high degree of attention.
6. Please take out the batteries and stop using immediately in case of below.
 - *This product is dropped or shocked seriously and the inner part of the product is bared.
 - *If this battery leaks corrosive liquids, please take out the battery with gloves.
 - *The product gives off strange smell, smokes or heats.
 - *Do not disassemble or maintain this product. Touching the internal high voltage circuit will cause electric shock.
 - *Remove batteries during long periods of non-use.

X Features

- * Wireless triggering sensor: It can work in outdoor environment under S1 and S2 mode, the wireless triggering distance is up to 10-15M in outdoor, 20-30m in indoor.
- * Super speed of charging recycle: It only takes 4 seconds in charging
- * The improved power saving mode: In the power saving mode, the flash will get automatic sleeping.
- * The brightness of the fine control: The brightness is more refined, 8 levels of output control(1/128-1/1), every level has six fine adjustments, cooperate different zoom values to get the flash effects what you demand for.

X Nomenclature

- 1.Reflection board
- 2.Wide-angle diffuser
- 3.Flash head
4. Wireless sensor
- 5.Battery compartment cover
- 6.Hot shoe stand
- 7.Fixed dial
- 8.Contacts
9. Locking pin

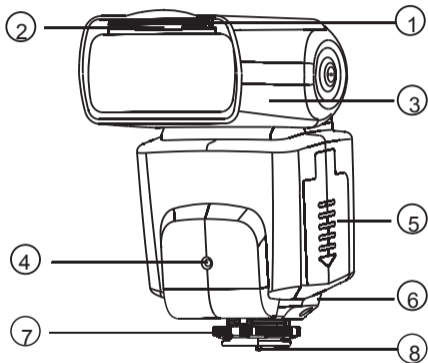

X Nomenclature

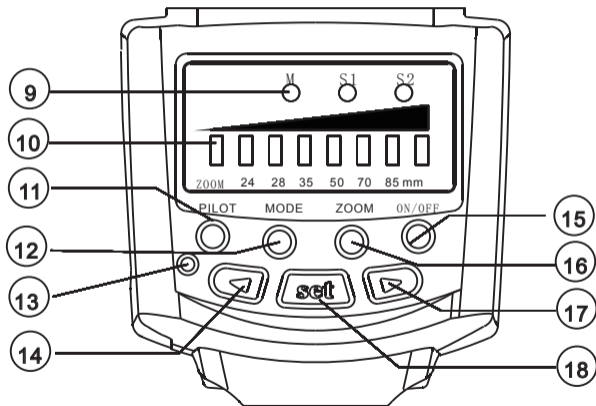

X Nomenclature

10. Mode indicator(M,S1 and S2): It indicates the current flash mode.
11. Output level indicator: It can regulate the output power by setting the button, there are 8 levels for output level adjustment. It indicates the output power and the fine-tuning; it indicates the coverage of the current focus length when adjusting the focus length
12. Test button
13. Mode switch button: The mode of the flash light will be switched among the M/S1/S2 in circle for each press.
14. Charging indicator/Test button: The lighting of green light shows that charging process is finished and flash can be used. the lighting of red light shows that it is in charging, the alternate flashing of the green lights shows overheat protection. The red light blinking shows that shortage of power.
15. Power adjust button: The output power of the flash light can be adjusted through left button
16. Power switch: The power of the flash light can be opened or closed by holding this button for 2 Seconds.
17. Lamp holder electric zoom button
18. Power adjust button: The output power of the flash light can be adjusted through right button
19. "SET"button: power adjust button

X Installation Instruction

1. Install Batteries

Slide the batteries chamber's cover in the direction of the arrow. Insert the batteries according to the label inside battery chamber. Make sure the direction of the batteries' polarity is correct. Close the battery chamber cover in the direction of the arrow.

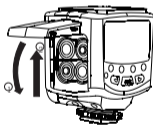
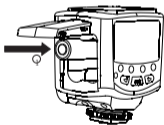
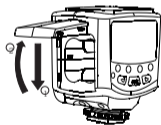



2. Mount the speedlite on your camera

- Loosen the locking ring by turning it in the direction of the arrow.
- Slide the speedlite hot shoe stand into the camera hot shoe stand until it stops. Turn the locking ring in the direction of the arrow tighten.
- To detach the speedlite, loosen the locking ring by turning it in the opposite direction.

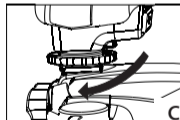
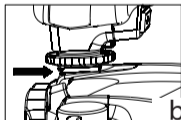
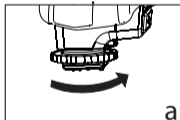



Basic functions

1. Basic Operations

Operation of the buttons:

Component	Operation
<Power Switch>	Power Switch of the flash light. The power of the flash light can be opened or closed by holding this button for 2 seconds. It is suggested that the battery shall be taken out after the power of the flash light is closed through this button.
<Mode Switch Button>	The mode of the flash light will be switched among the M/S1/S2 in circle for each press.
Power and focus adjustment <LEFT> and <RIGHT> button	The output power and focus of the flash light can be adjusted through these buttons
Power fine adjust <SET> button	Press SET button into the fine adjust function
<ZOOM> button	Please press Zoom Button into the fine adjust state, and cooperate left and right button for adjust focus range, The head focus of the flash light will switch among the (24/28/35/50/70/85/105) in circle for each press.
<Pilot Button>	Press the test and the flash will test flashing in current output level



Meaning of <Charging indicator>:



Meaning of (Output control indicator) represents <ON> state of indicator's light. While 0 represents <OFF> state.

In M/S1/S2 Mode, indicates the output level	
State of <Output level indicator>	Output level
0 0 0 0 0 0 0 0	1/128
0 0 0 0 0 0 0 0	1/64
0 0 0 0 0 0 0 0	1/32
0 0 0 0 0 0 0 0	1/16
0 0 0 0 0 0 0 0	1/8
0 0 0 0 0 0 0 0	1/4
0 0 0 0 0 0 0 0	1/2
0 0 0 0 0 0 0	1/1

<Charging indicator> State	Meaning	Operation
The green light is lit	The Flash lighth is fully charged, and can be used.	Normal
The red light is lit	The Flash lighth has not been fully charged	If the red light is lit for 20 seconds, replace the batteries.
The green lights blink alternatively	The Flash lighth is locked to prevent overheating due to frequent flashing.	Wait indicator to be green
The red lights blink alternatively	Long time charged shortage of power supply	Charge time over 20S, please replace batteries



2. Turn ON/OFF:

- *The power of the flash light can be opened or closed by holding this button for 2 seconds. It is suggested that the battery shall be taken out after the power of the flash light is closed through this button.
- *After opening the power switch of the flash, the flash will fetch the setting state saved in the close down last time, the charging indicator is green, which indicates the flash is available.
- *If the charging is not completed within 20 seconds, shortage of power supply can not flash. Then you need to replace with new batteries.
- *You may press the testing button <PILOT> to test whether the flash works normally. After use, hold the power switch for 2S to power off.

3. M Mode

In M mode, you can set the flash output level as you like. you can adjust the flash output level. The adjustment range of the flash output level is 1/128-1/1. There are 8 levels of output and each level has 6 fine tuning stalls. The <left><right> is used to fine tune the output power. The output level is indicated by the output power indicator. For shooting, what you need is to set the flash output level, adjust the camera and press the shutter. The flash will flash with the synchronic signal of the camera.



4. S1/S2 modes

By pressing the <Mode Switch Button>, the flash will step into the S1/S2 mode. These two modes are suitable to be used as off-camera auxiliary light, so as to create a variety of lighting effects. They are suitable for manual flash environment and TTL flash environment respectively.

*Under these two modes, the way to adjust the output level is like that in M mode, which is to press the <LEFT><RIGHT> and <OK> in the middle. When using S1/S2 mode, you can rotate the flash head to make the wireless triggering sensor face with the master light. When the flash is in S1 mode, it will work with the first work of the master flash synchronously, with the result consistent with the use of radio slave. To use this mode correctly, the master flash should be set at manual flash and the TTL flash system with preflash function and the red-reduction function with multiple flashes should not be used.

*S2 mode: It is also called "pre-flash cancel mode". This mode is similar with S1 mode, but it can neglect the pre-flash given by TTL flash. Therefore, it can support the main flash working in TTL mode. In particular, if S1 mode cannot flash correctly and synchronically with your internal flash, you can try to use S2 mode.

5. Test Flash

Whether in any mode, you can press PILOT button to test if the flash light flashed normally. When testing the flash, the flash will give flash at relevant output level in accordance with the chosen output power setting.



6. Flash will eningy power save mode : if 30s have any operation, It can be wake up through any button

7. Overheating proteciton

If the flash light is used too frequently,its overheating protection funciton will be triggered, the red and green lights of the charging indicator will blink alternatively,and the flash light will be locked. in such case, wait indicator to be green then cancel the protection before continuing the use.



* Please try to use the 1/4 output or lower when rapid shooting is needed to prevent the effect on the shooting.

















8. Manually set the zooming position

By pressing ZOOM ,you can set the zooming position, zoom will change green light when focus adjust status.

Pressing < ▶ >and < ◀ >.the covered focus length of the flash will switch of (24/28/35/50/70/85mm).In setting the flash zooming position.the indicator in the operational panel will indicate the current position.The focus length showed by the displayed position can be found in the table below.

 represents<ON> state of indicator's light,while  represents<OFF>state. ○

Application of ZOOM to set the zooming position	
State of <output level indicator>	zooming <mm>
  ○ ○ ○ ○ ○ ○ ○ ○	24
 ○  ○ ○ ○ ○ ○ ○ ○ ○	28
 ○ ○  ○ ○ ○ ○ ○ ○ ○ ○	35
 ○ ○ ○  ○ ○ ○ ○ ○ ○ ○ ○	50
 ○ ○ ○ ○  ○ ○ ○ ○ ○ ○ ○ ○	70
 ○ ○ ○ ○ ○  ○ ○ ○ ○ ○ ○ ○ ○	85
 ○ ○ ○ ○ ○ ○ ○ 	105

X The Advanced Application

1. Output power fine adjust function:

Press the "SET" button, Among two power indicator lights up , through the left and right key for fine-tuning, every time fine-tuning value one third, When make sure the parameters, then press <SET > key again can save and quit, or after 15 seconds later Automatic save and exit.

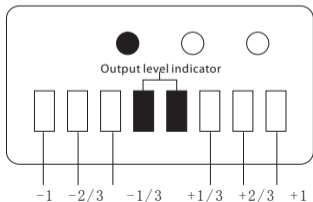



2. Multi-flash Lighting Application

Use inbuilt flash or top-mounted flash as master flash, Place multi-speedlite in different directions.

*In indoor application, radio signals can be reflected by walls; therefore, the placement of the slave flash should have more space. Wireless triggering distance is up to 20-30M.

*which can be available in outdoor state. The Wireless triggering distance is as long as 10-15M, Please keep in mind the following tips; the wireless triggering window needs to face the master flash and the direct sunlight shall be avoided. If these demands conflict with your hoped direction of light irradiation, please try to rotate the flash head in each direction in order to meet the shooting demands.

*Before placing of the slave flash, test whether S1/S2 can be synchronous normally, Do not place any obstacles between the host flash and the slave flash, because they may block the transmission of radio signals.

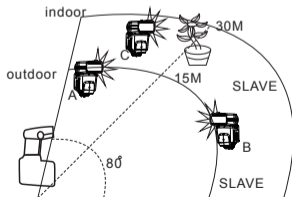



3. Reflection Flash

Bounce flash means to take photos by making flash light head aimed at wall or ceiling and using the light reflected back from the ceiling or wall to light the desired object, so that the shade behind the object can be decreased to get more natural shooting effect. If the wall or ceiling is too far, the bounce flash may be too weak to get enough exposure. The wall or ceiling should be even and white in order to get efficient reflection; if the reflection surface is not white, color cast may appear in photo.

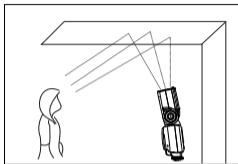

4. Use Reflection Board to Take Photos

With the reflection board flash, draw the reflection board and the wide-angle diffusion board out from the light head at the same time and then push the wide-angle diffusion board back. In such case, if this product is being used to take photos, it will produce a high lighted point on the eyes of the subject and thus make the eyes charming (catch light). This function can reach optimal effect when the flasher head is up 90 degrees.

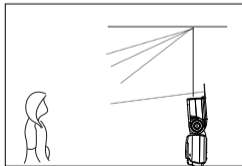



5. Use **Wide-angle Diffuser**

Pull out the wide-angle diffusion board, push back the reflection board and arrange them as per the figure; in such case, the flash scopes will extent to 18 mm and the flash effect will be softer and more natural.

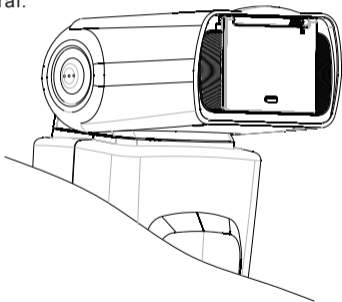

X Specifications

Guide Number	85 meters (ISO 100,85mm)
Flash mode	M,S1,S2
Vertical rotation angle	0-90 degrees
Horizontal rotation angle	0-270 degrees
Power supply	4XAA size batteries(Alkaline or Ni-MH are usable)
Lighting times	100-1500 times(AA alkaline cell used)
Recycle time	approx 4s
Color temperature	5600k
Flash time	1/500s-1/20000s
Flash control	8 levels of output control(1/128-1/1), every level have six fine adjustment
External interface	hot shoe
Wireless triggering distance	20-30m indoor,10-15m outdoor
Additional features	Power saving mode and over heat protection
Dimensions	165x74.6x59.2mm
Net weight	250g
Accessories	Flash light(1),protecting bag(1),mini stand(1) and manual(1), warranty card(1)



Guide number of different focus length range GN85 ISO 100 (meters / feet)

Flash output	Coverage(MM)						
	24	28	35	50	70	85	105
1/1	20/66	22/72.6	25/82	27/88.6	30/98.3	33/109.2	36/118.1
1/2	12.2/40.1	15.3/45.9	17.7/58.1	19.1/62.7	21.9/71.9	24/87.7	26.2/86
1/4	8.8/28.9	11/36.1	12.5/41	13.5/44.3	15.5/50.9	17/55.8	18.5/60.7
1/8	6.3/20.7	7.8/25.6	8.8/28.9	9.5/31.2	11/36.1	12/39.4	13.1/43
1/16	4.4/14.4	5.5/18	6.3/20.7	6.8/22.3	7.8/25.6	8.5/27.9	9.3/30.5
1/32	3.1/10.2	3.9/12.8	4.4/14.4	4.8/15.7	5.5/18	6/19.7	6.5/21.3
1/64	2.5/8.2	3.2/10.5	3.1/10.2	3.4/11.2	3.9/12.8	4.3/14.1	4.6/15.1
1/128	2.5/8.2	2.7/8.9	3.2/10.5	3.7/12.1	4.4/14.4	4.7/15.4	5.1/16.7

X Possible problems during use and solutions

1. Please note when use the flash outdoors: For outdoor application, please avoid direct sunlight to the wireless triggering sensor and ensure normal use of the flash.
2. Precaution for outdoor use of lamency umbrella; The lamency umbrella mounted on the flash light outdoors may be blown down easily, and the hot shoe of the flash light may be broken. Please fix the mounting rack or avoid outdoor use.
3. Photos are under exposure or over exposure? Check if the set shutter, aperture and ISO are too near the flash limit or if some settings including exposure compensation in relation to flash are proper.
4. Vignetting appears in photos or only part of the subject is illuminated? Please check the current coverage of focus length and make sure if the lens focus length exceeds the coverage range of the flash. The products's zooming range is 24-105mm of the medium format system. you can try to pull out the wide-angle diffuser to expand the flash range.
5. The flash light is abnormal? Switch off the power of flash light and camera, mount the flash light on the hot shoe of camera, and switch on the power of flash light and camera again, if the abnormality continues, replace the batteries.
*Caution: long time no use, please fetch out batteries.

The functions of this manual are based on test conditions of our company. Further notice will not be given if the design and specifications change.

capture the spot™

